

Analogue : Digital Stillness : Movement UpScale 2021

Lachlan Larney-Dawson & Rosie Ward

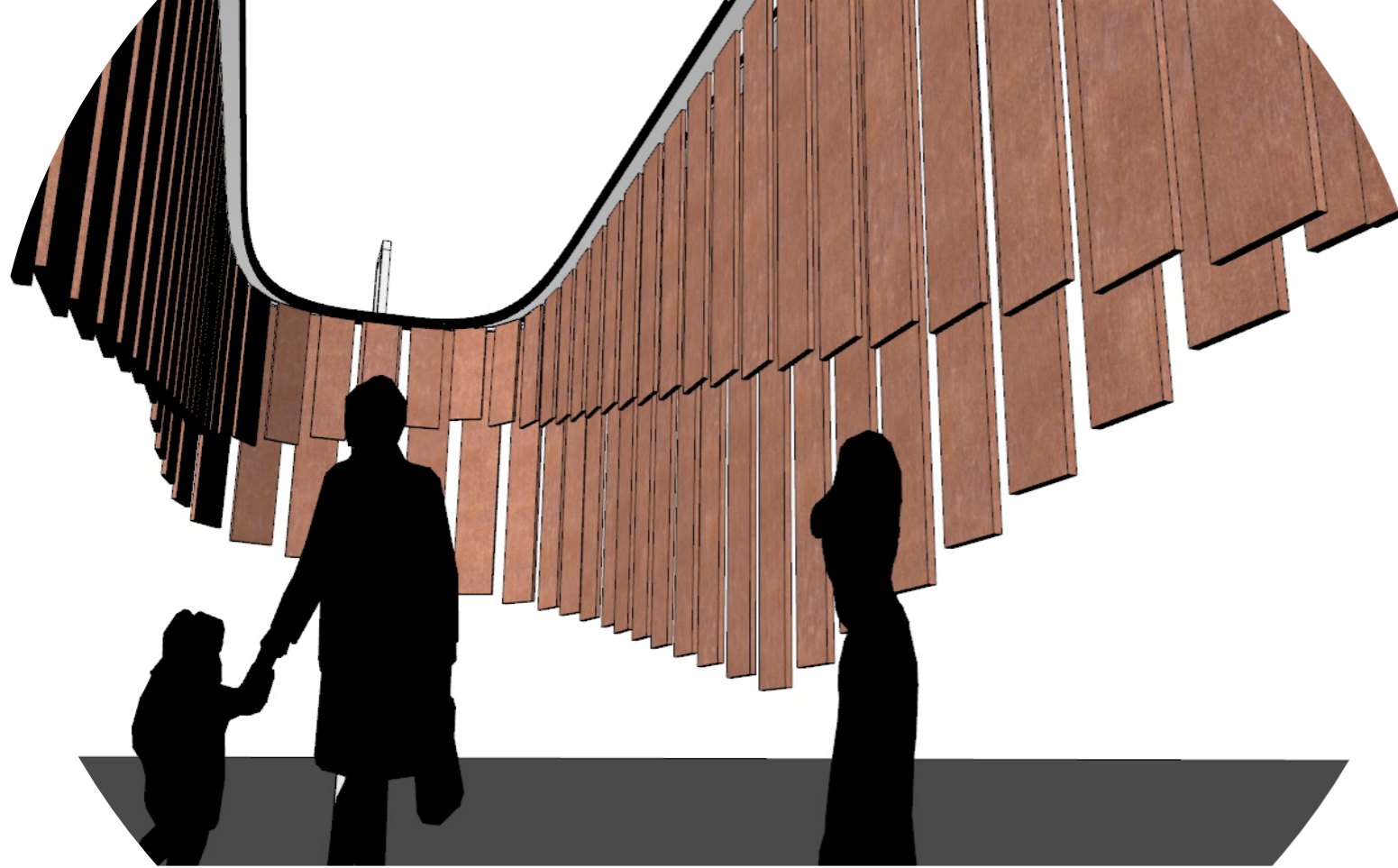



Perforated corten steel for the primary components

Movement & Function

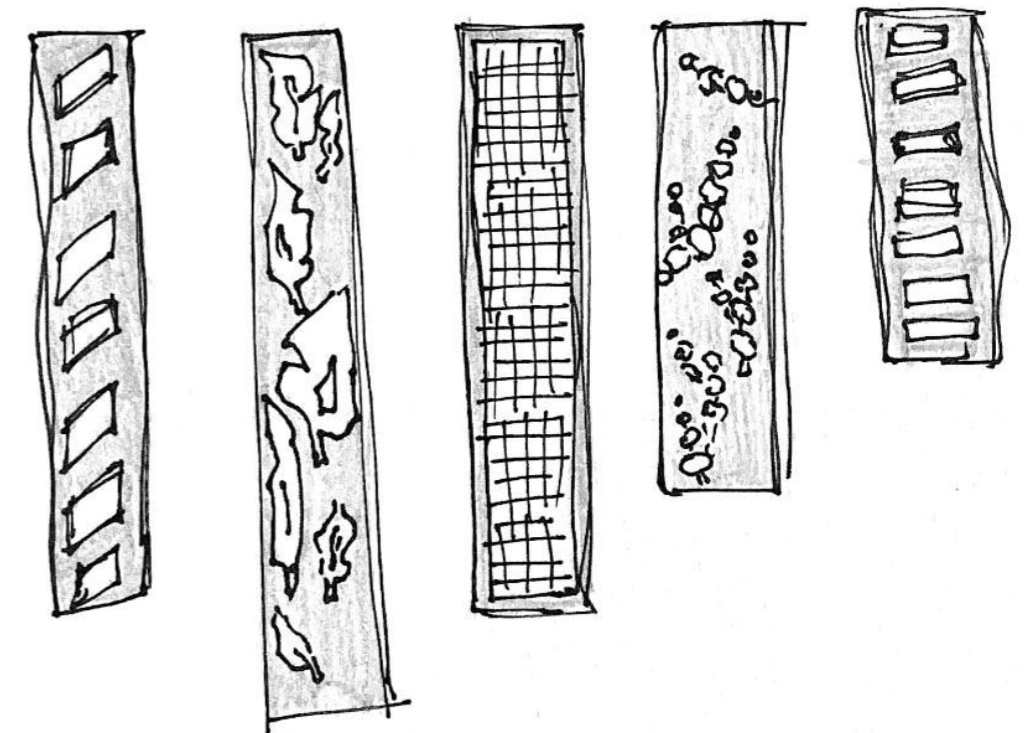
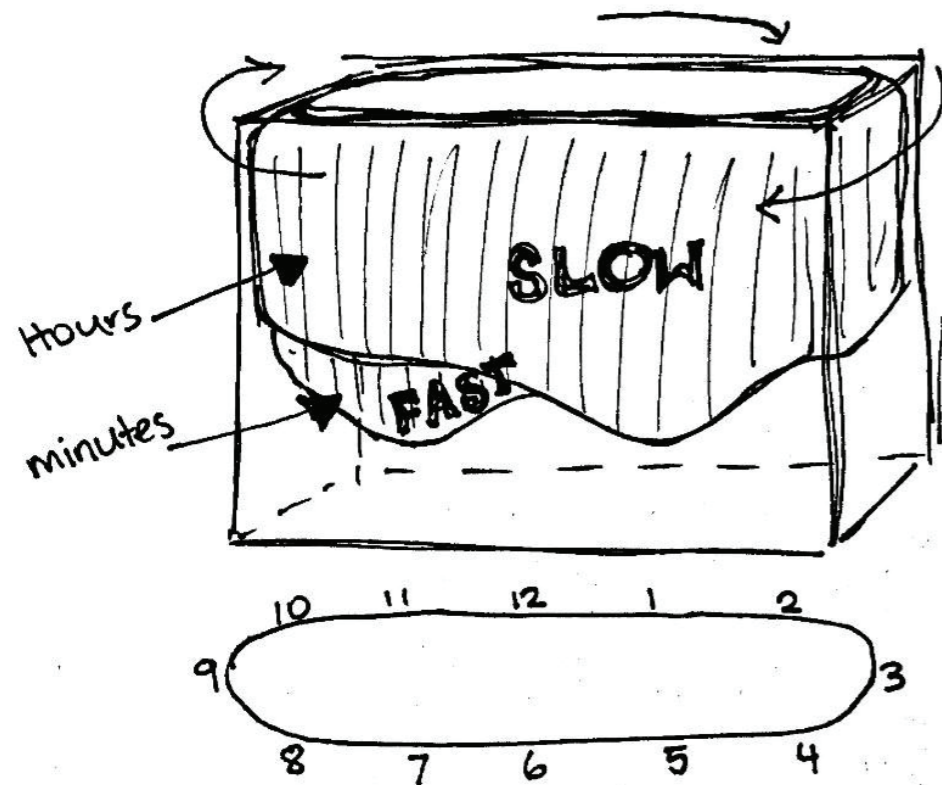

Light Permeability of components
Creates both an illusion upon alignment as well as disperses the light in particular ways

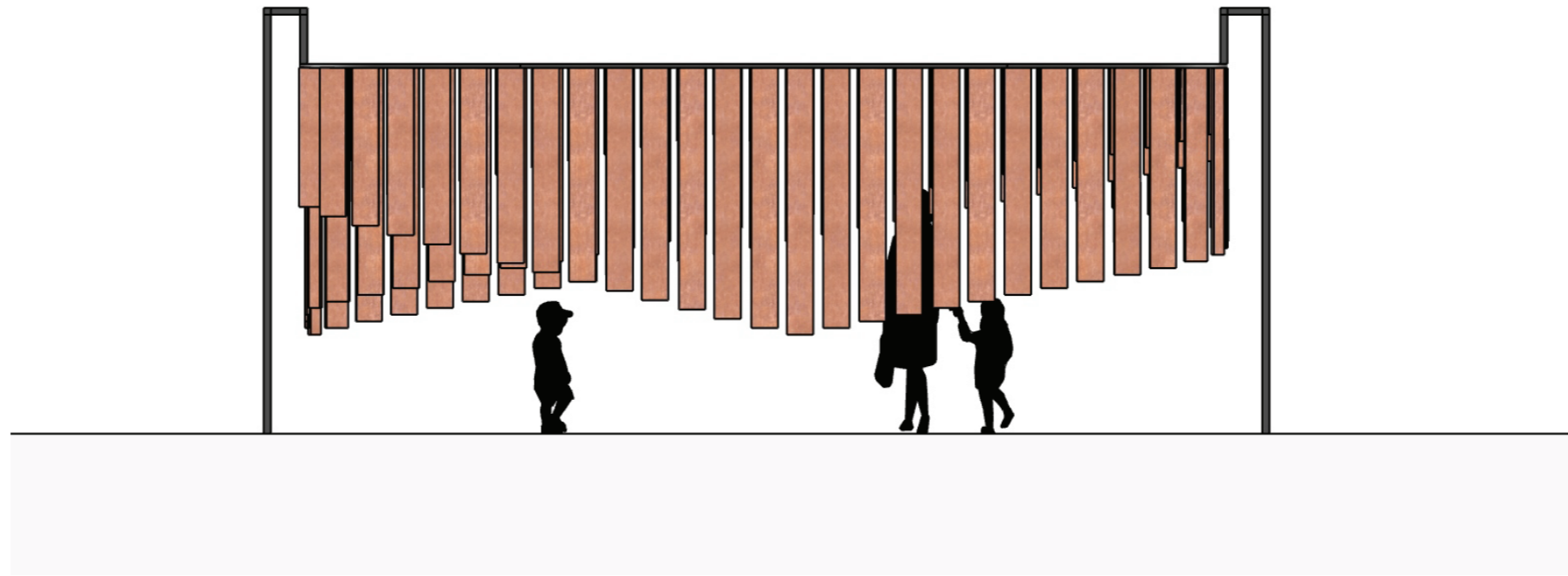

General Concept

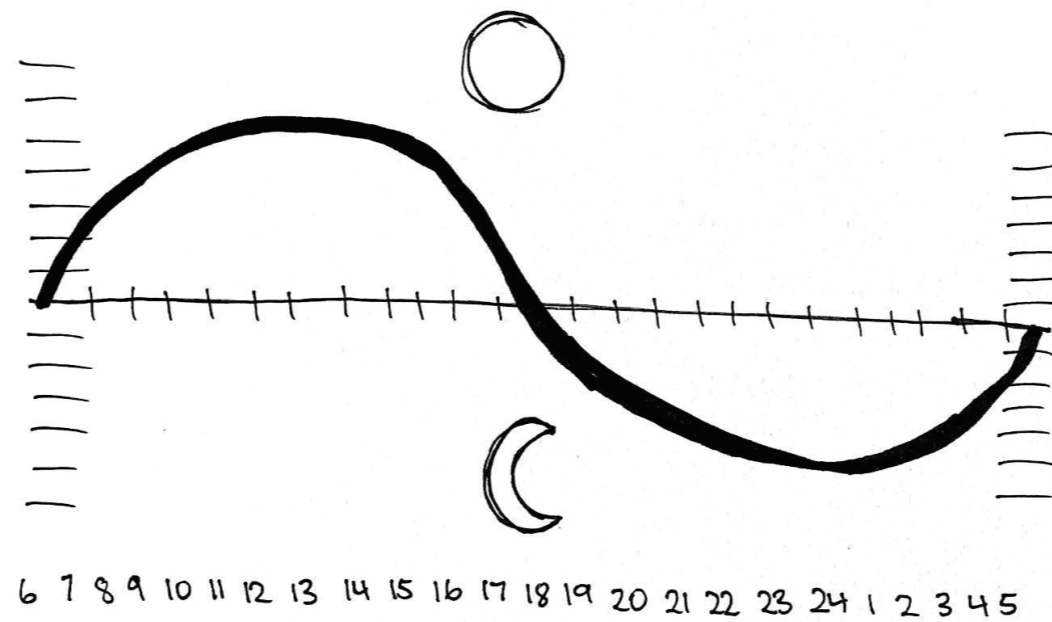

Clock work function

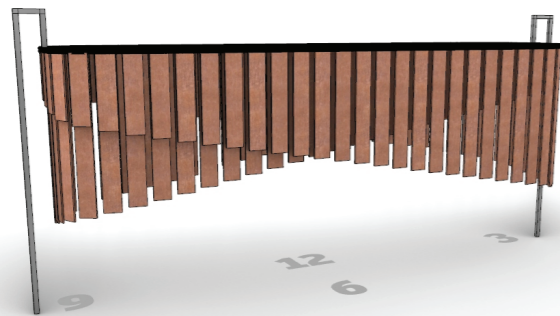

3:45

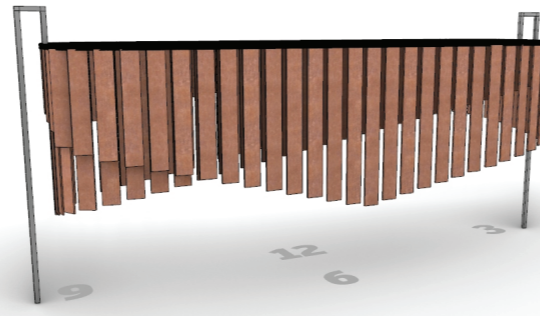

6:45

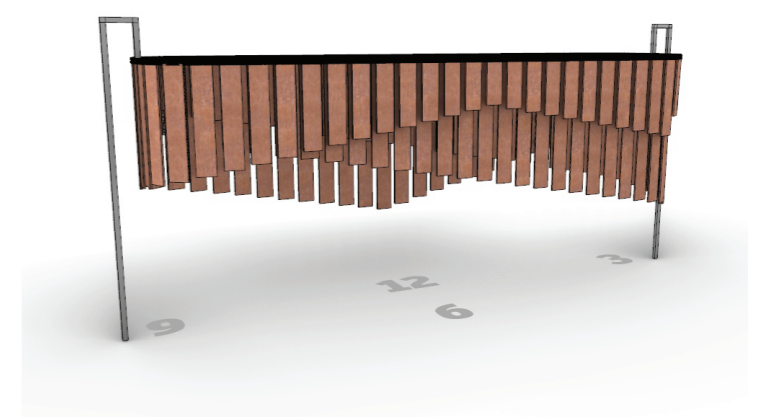

12:15

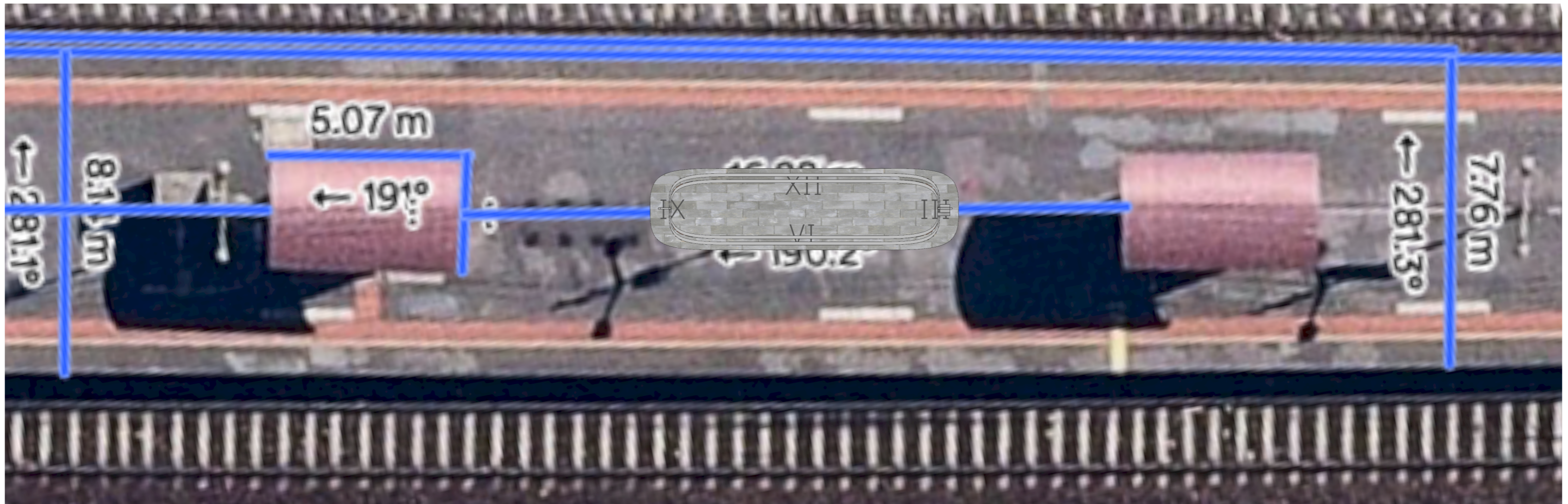

SCALE 1:100

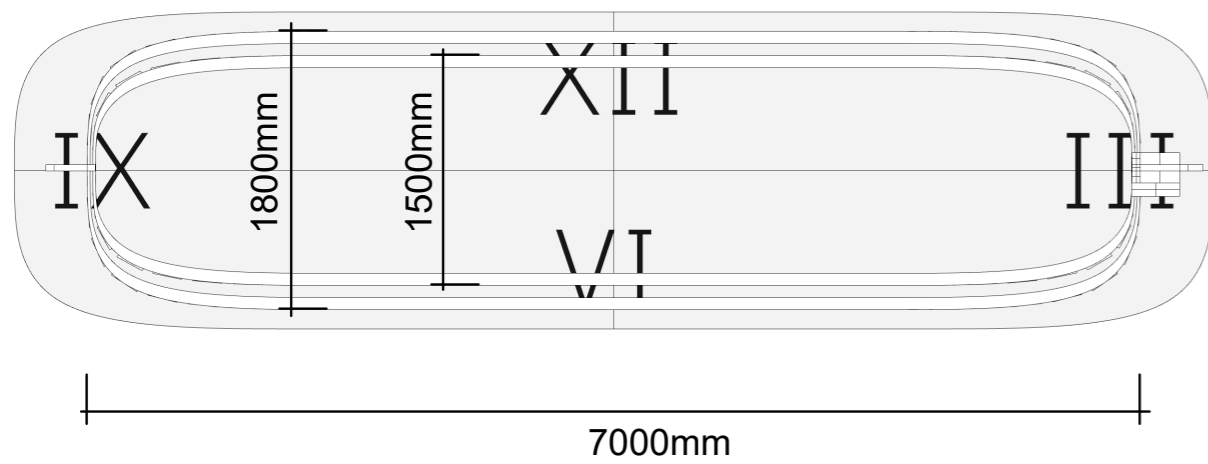

SCALE 1:50

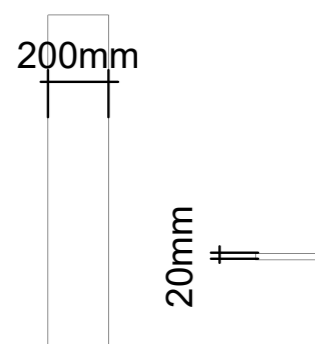
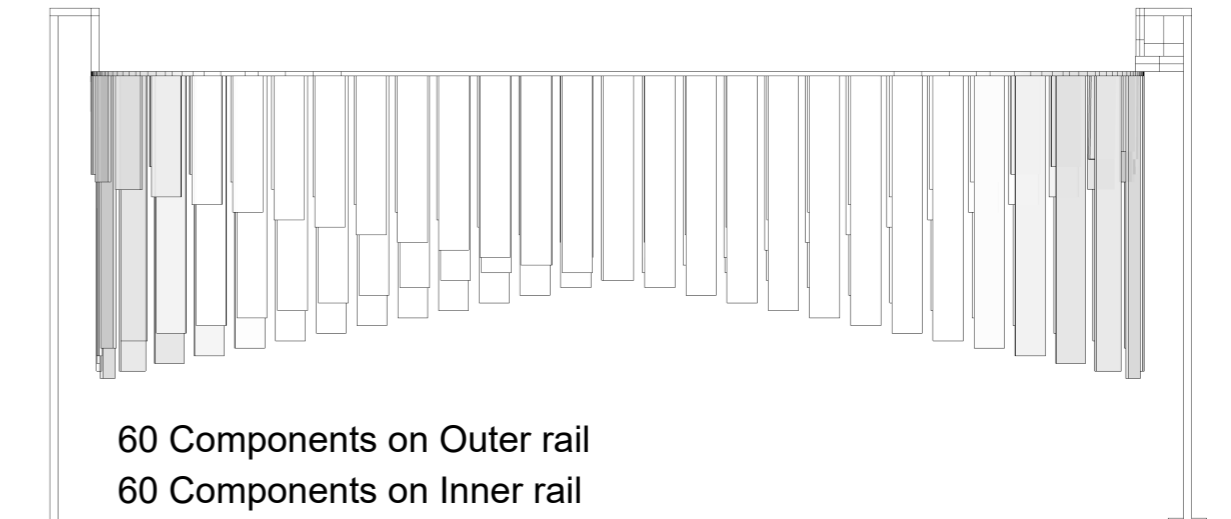
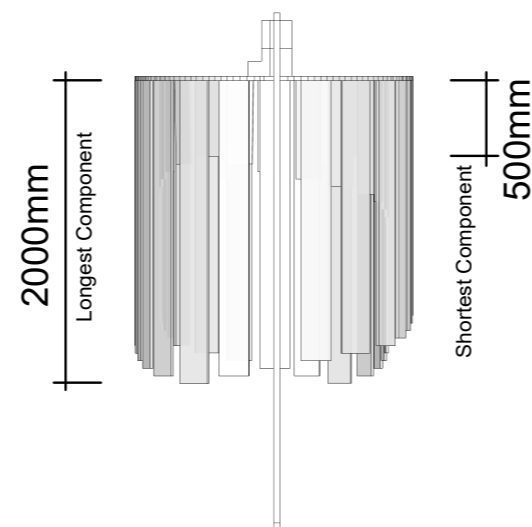

SCALE 1:25

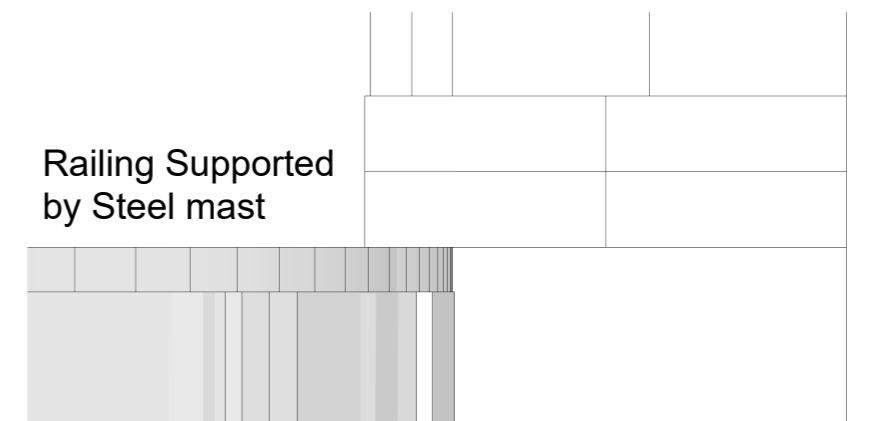
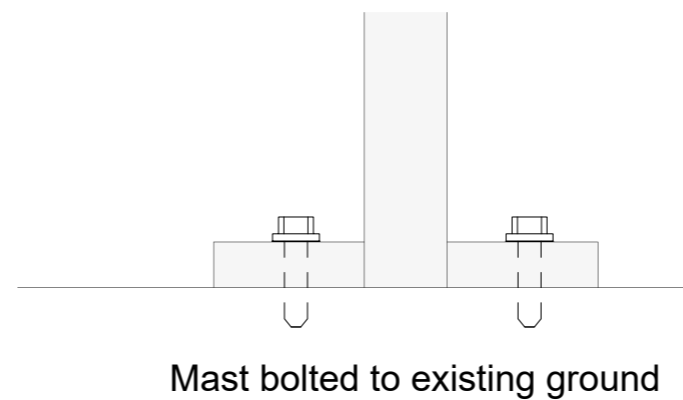

SCALE 1:5